

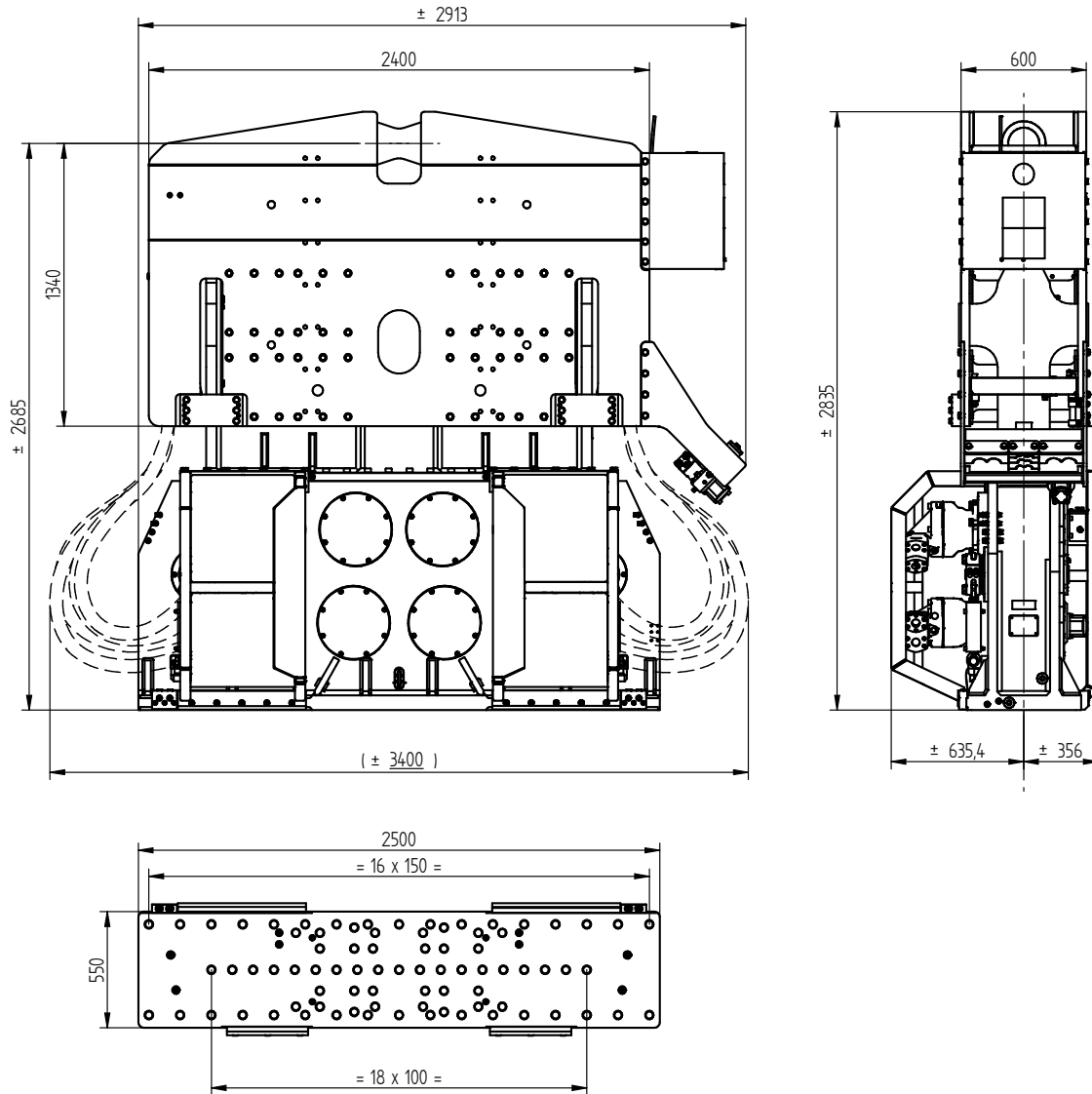

Specification sheet

PVE 50VM

Vibro Hammer



Specifications :

PVE 50VM

Eccentric moment	0-50 kgm	Clamps:	
Max. centrifugal force	0-2900 kN	Sheet pile clamp	350TU
Max. frequency	2300 rpm	Transport weight per piece	2600 kg
Max. amplitude excl. 350TU	15 mm	Double clamps	175TC
Max. amplitude incl. 350TU	10,9 mm	Transport weight per piece	1300 kg
Max. static line-pull	800 kN		
Max. pull-down	300 kN		
Max. operating pressure	350 bar	Powerpack:	
Max. oil flow	1380 l/min	Model	1400 series
Max. hydraulic power	805/1095 kW/HP		
Forced lubrication	yes		
Dynamic weight excl. 350TU	6600 kg	Hose set:	
Dynamic weight incl. 350TU	9200 kg	Length	45 m
Total weight excl. 350TU & hoses	10060 kg	Transport weight (±)	1970 kg

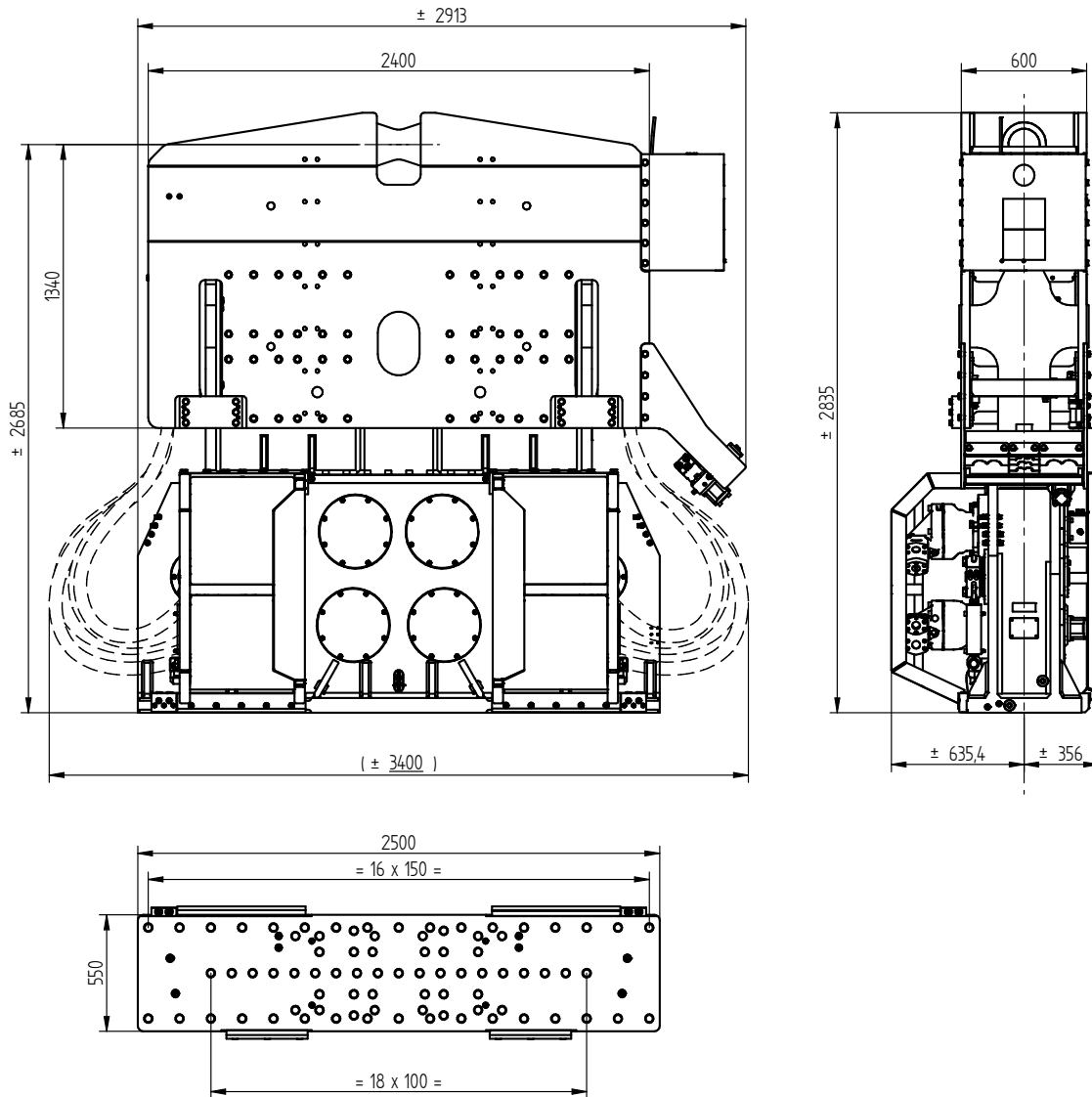

Technische Daten :

PVE 50VM

Statisches Moment	0-50 kgm	Klemmzange:	
Max. Fliehkraft	0-2900 kN	Universalzange	350TU
Max. Drehzahl	2300 rpm	Transportgew. pro Stück	2600 kg
Max. Amplitude ohne 350TU	15 mm	Rohrklemmzange	175TC
Max. Amplitude mit 350TU	10,9 mm	Transportgew. pro Stück	1300 kg
Max. Statische Zugkraft	800 kN		
Max. Vorspannung	300 kN		
Max. Betriebsdruck	350 bar	Aggregat:	
Max. Fördermenge	1380 l/min	Modell	1400 series
Max. hydraulische Leistung	805/1095 kW/PS		
Zwangsschmierung	ja		
Dyn. Gewicht ohne 350TU	6600 kg	Schlauchsatz:	
Dyn. Gewicht mit 350TU	9200 kg	Länge	45 m
Gesamtgew. Ohne 350TU & Schläuche	10060 kg	Transportgewicht (±)	1970 kg



Spécifications

PVE 50VM

Vibro Hammer

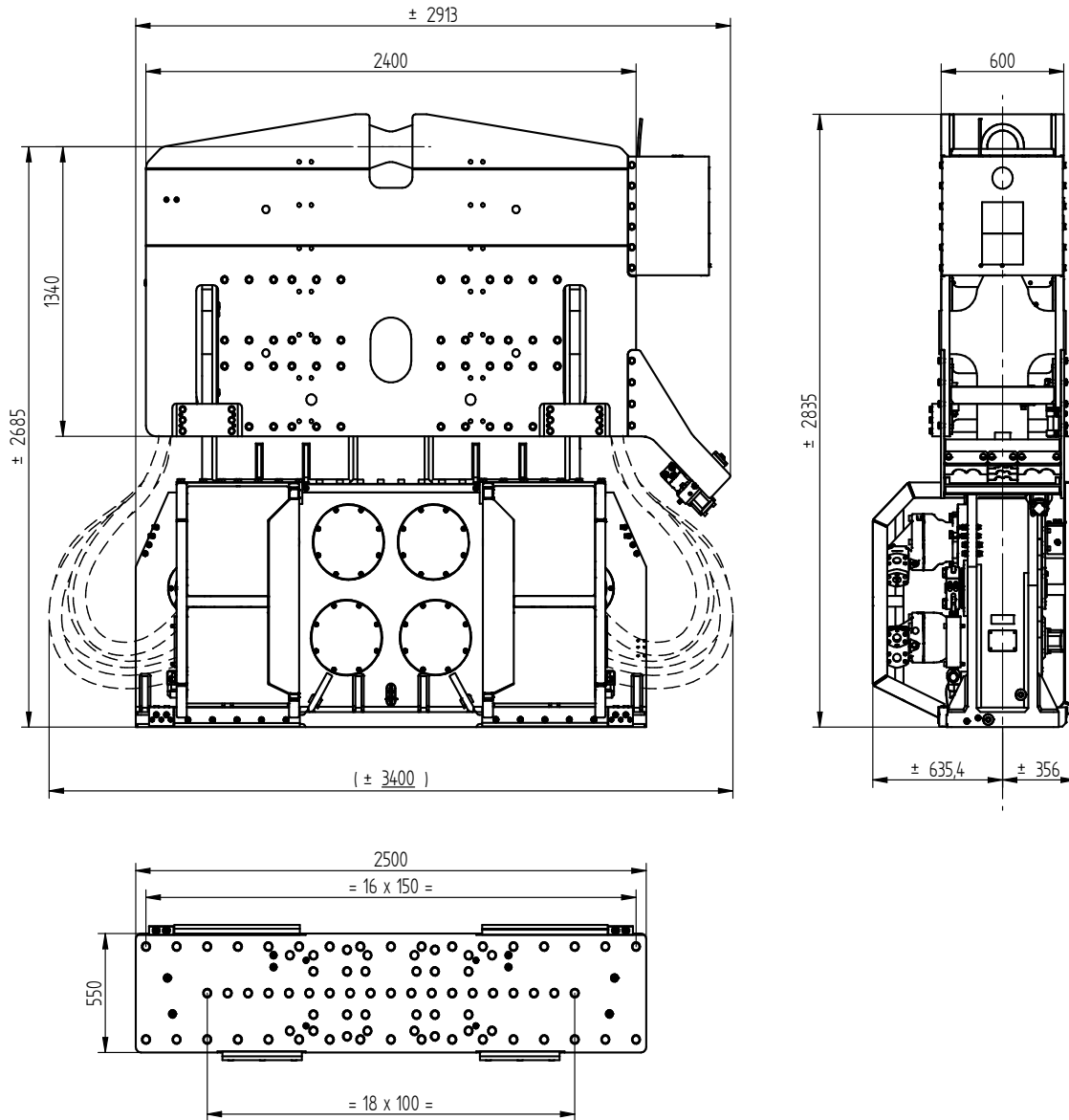

Spécifications

PVE 50VM

Moment excentrique	0-50 kgm	Pincés:	
Max. force centrifuge	0-2900 kN	Pince palplanche	350TU
Max. fréquence	2300 rpm	Poids de transport par pièce	2600 kg
Max. amplitude sans 350TU	15 mm	Pince tube	175TC
Max. amplitude avec 350TU	10,9 mm	Poids de transport par pièce	1300 kg
Force de traction statique	800 kN		
Force maximale d'appui	300 kN		
Pression de travail max.	350 bar	Groupe hydraulique:	
Débit d'huile max.	1380 l/min	Modèle	1400 series
Puissance hydraulique max.	805/1095 kW/ch		
Huile lubrifiante	oui		
Poids dynamique sans 350TU	6600 kg	Jeu de tuyau:	
Poids dynamique avec 350TU	9200 kg	Longueur	45 m
Poids total sans 350TU & tuyaux	10060 kg	Poids de transport (±)	1970 kg

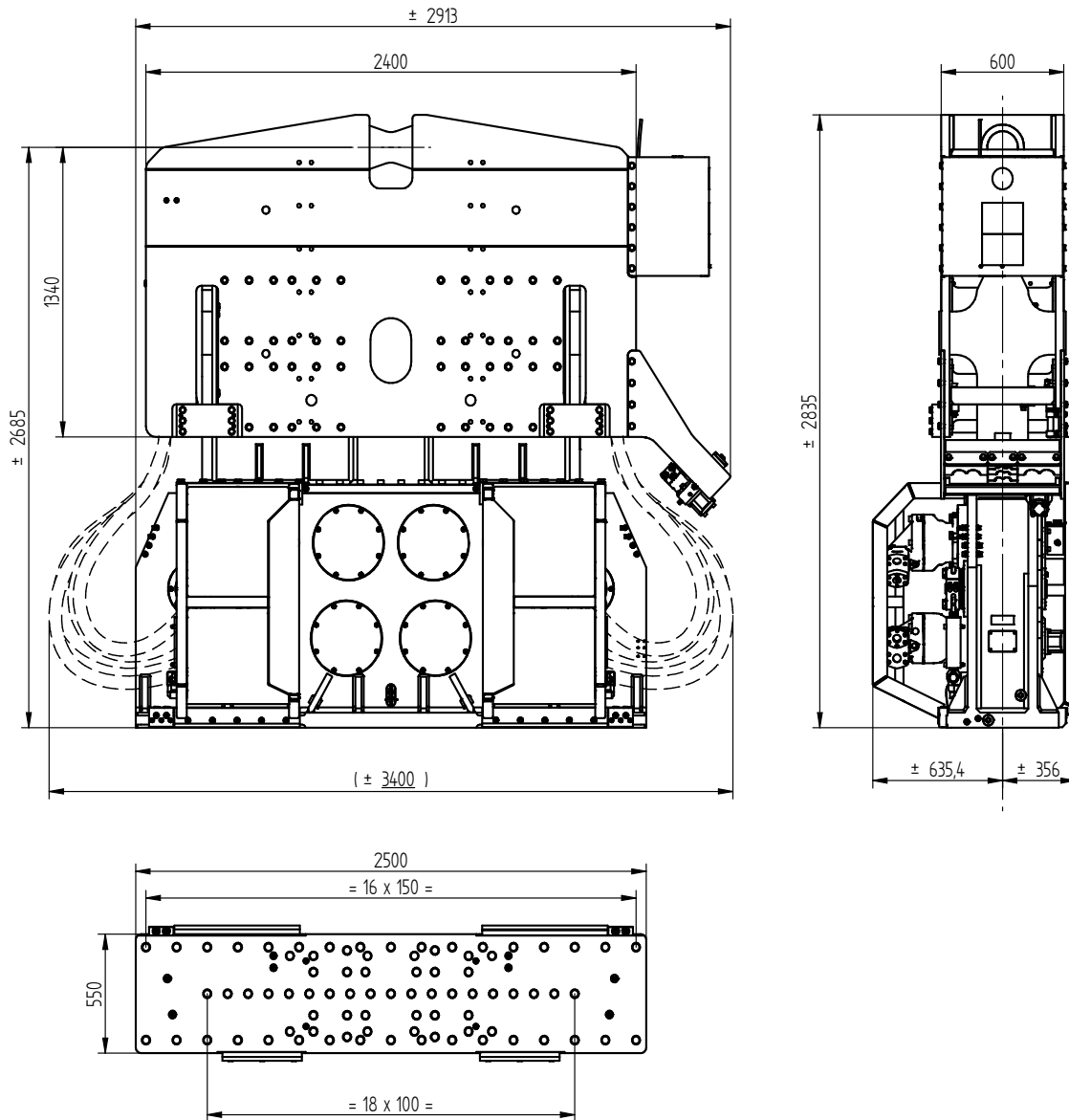

Specificaties

PVE 50VM

Excentrisch moment	0-50 kgm	Klemmen:	
Max. centrifugaalkracht	0-2900 kN	Damwandklem	350TU
Max. toerental	2300 rpm	Transportgewicht per klem	2600 kg
Max. amplitude excl. 350TU	15 mm	Pijpenklem	175TC
Max. amplitude incl. 350TU	10,9 mm	Transportgewicht per klem	1300 kg
Max. statische trekkracht	800 kN		
Max. voorspanning	300 kN		
Max. werkdruk	350 bar	Aggregaat:	
Max. oliedoorstroming	1380 l/min	Model	1400 series
Max. hydraulisch vermogen	805/1095 kW/PK		
Geforceerde smering	ja		
Dynamisch gewicht excl. 350TU	6600 kg	Slangenset:	
Dynamisch gewicht incl. 350TU	9200 kg	Lengte	45 m
Totaalgewicht excl. 350TU & slangen	10060 kg	Transportgewicht (±)	1970 kg



Especificaciones

PVE 50VM

Vibro Hammer

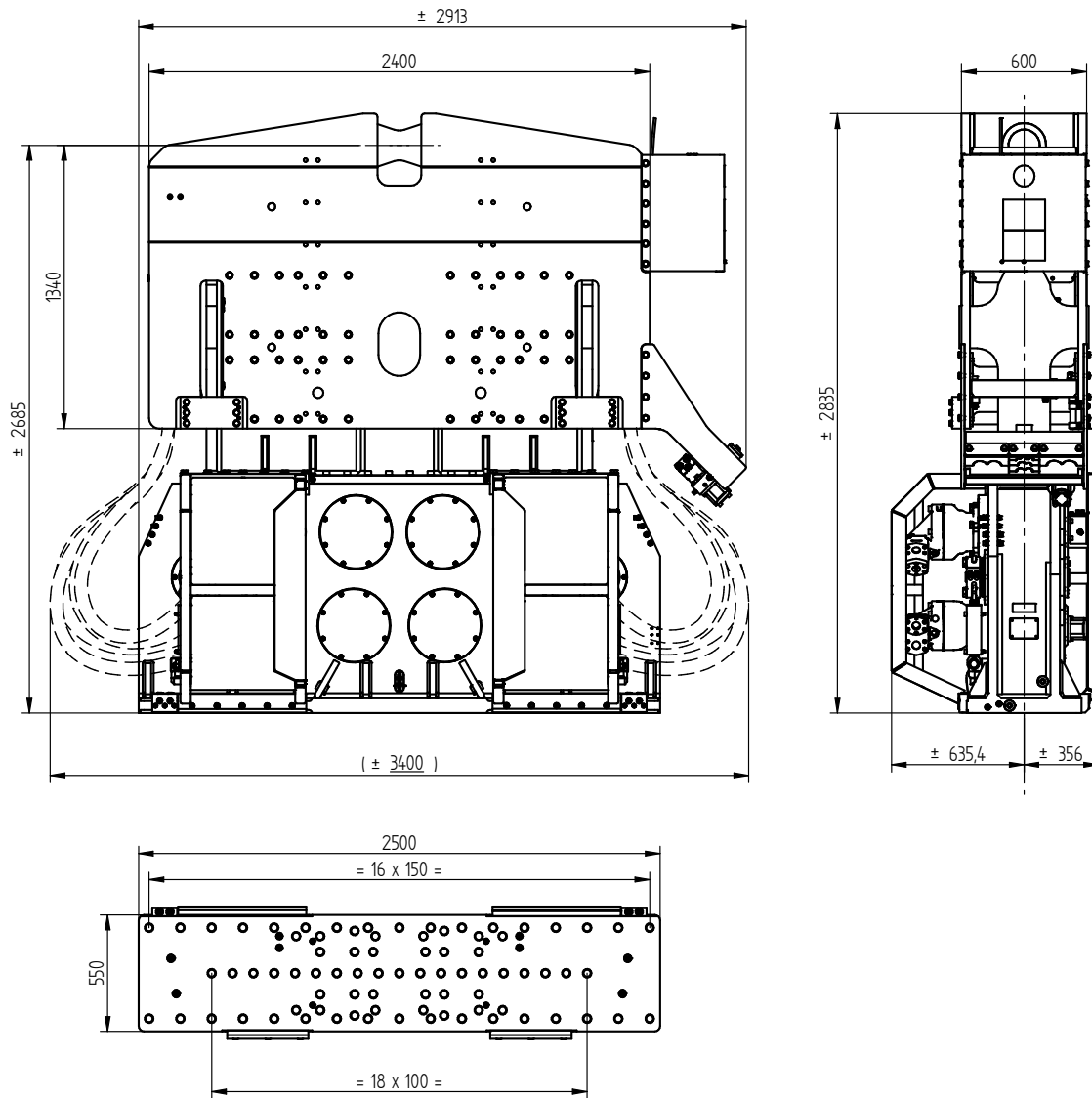

Especificaciones

PVE 50VM

Momento excéntrico	0-50 kgm	Abrazadera:	
Fuerza centrífuga máxima	0-2900 kN	Hoja abrazadera pila	350TU
Frecuencia máxima	2300 rpm	Peso de transporte por pieza	2600 kg
Amplitud máxima excluyendo 350TU	15 mm	Abrazadera de tubo	175TC
Amplitud máxima incluyendo 350TU	10,9 mm	Peso de transporte por pieza	1300 kg
Estático tracción máxima	800 kN		
Compresión máxima	300 kN		
Presión máxima de trabajo	350 bar	Unidad de potencia:	
Flujo de aceite máximo	1380 l/min	Modelo	1400 series
Máxima potencia hidráulica	805/1095 kW/HP		
Lubricación forzada	si		
Peso dinámico excluyendo 350TU	6600 kg	Conjunto de manguera:	
Peso dinámico incluyendo 350TU	9200 kg	Longitud	45 m
Peso total excluyendo 350TU & mangueras	10060 kg	Peso de transporte (±)	1970 kg



Specifications

PVE 50VM

Vibro Hammer

USA

Dimensions in inches

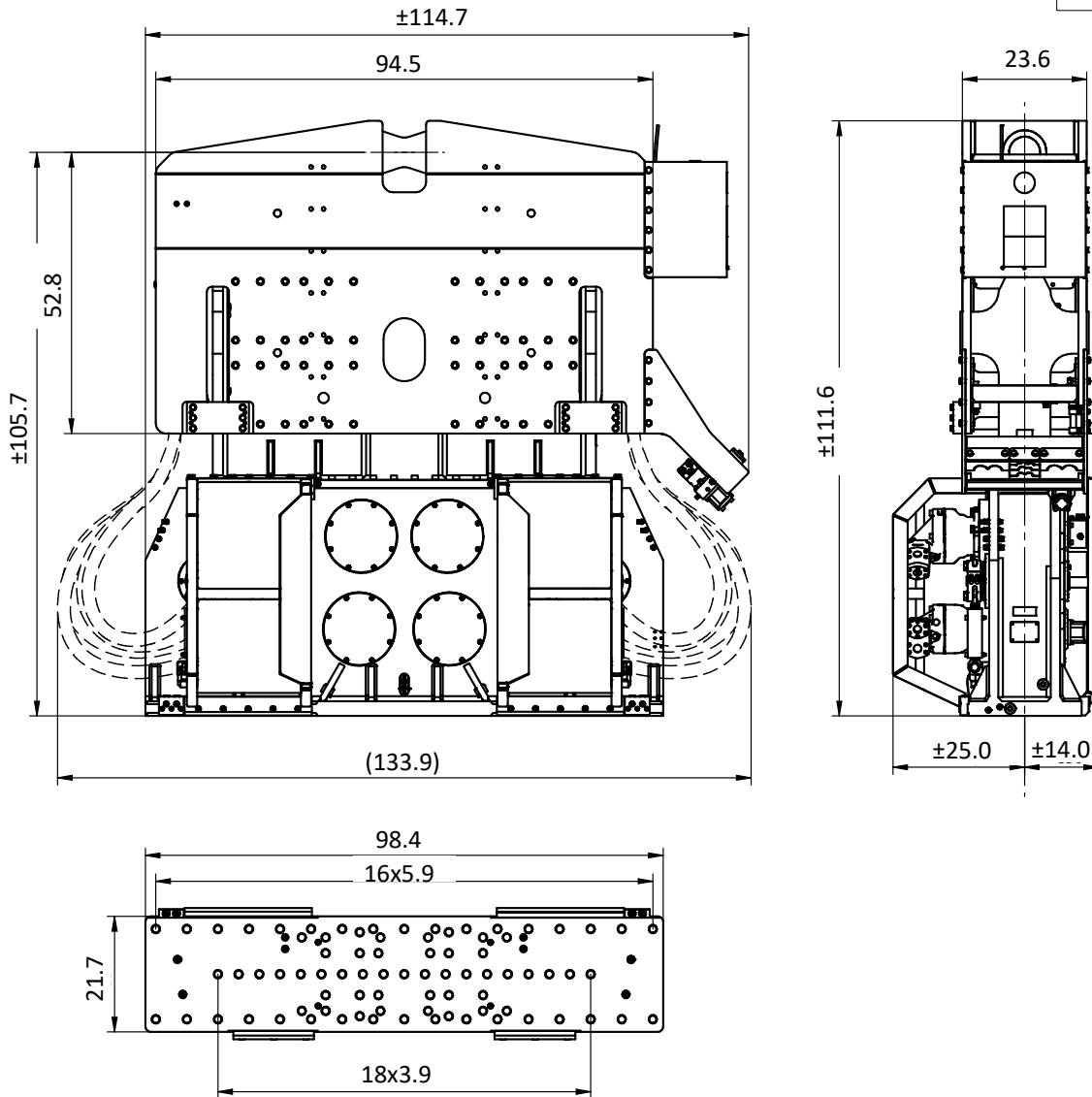

Specifications

PVE 50VM

Eccentric moment	0-4,340 in-lbs	Clamps:	
Max. centrifugal force	0-326 ton	Sheet pile clamp	350TU
Max. frequency	2,300 rpm	Transport weight per piece	5,732 lbs
Max. amplitude excluding 350TU	0.59 in	Double clamps	175TC
Max. amplitude including 350TU	0.43 in	Transport weight per piece	2,866 lbs
Max. static line-pull	82 ton		
Max. pull-down	31 ton		
Max. operating pressure	5,076 psi	Powerpack:	
Max. oil flow	365 gal/min	Model	1400 series
Max. hydraulic power	805/1095 kW/HP		
Forced lubrication	yes		
Dynamic weight excluding 350TU	14,551 lbs	Hose set:	
Dynamic weight including 350TU	20,283 lbs	Length	148 ft
Total weight excluding 350TU & hoses	22,179 lbs	Transport weight (±)	4,343 lbs

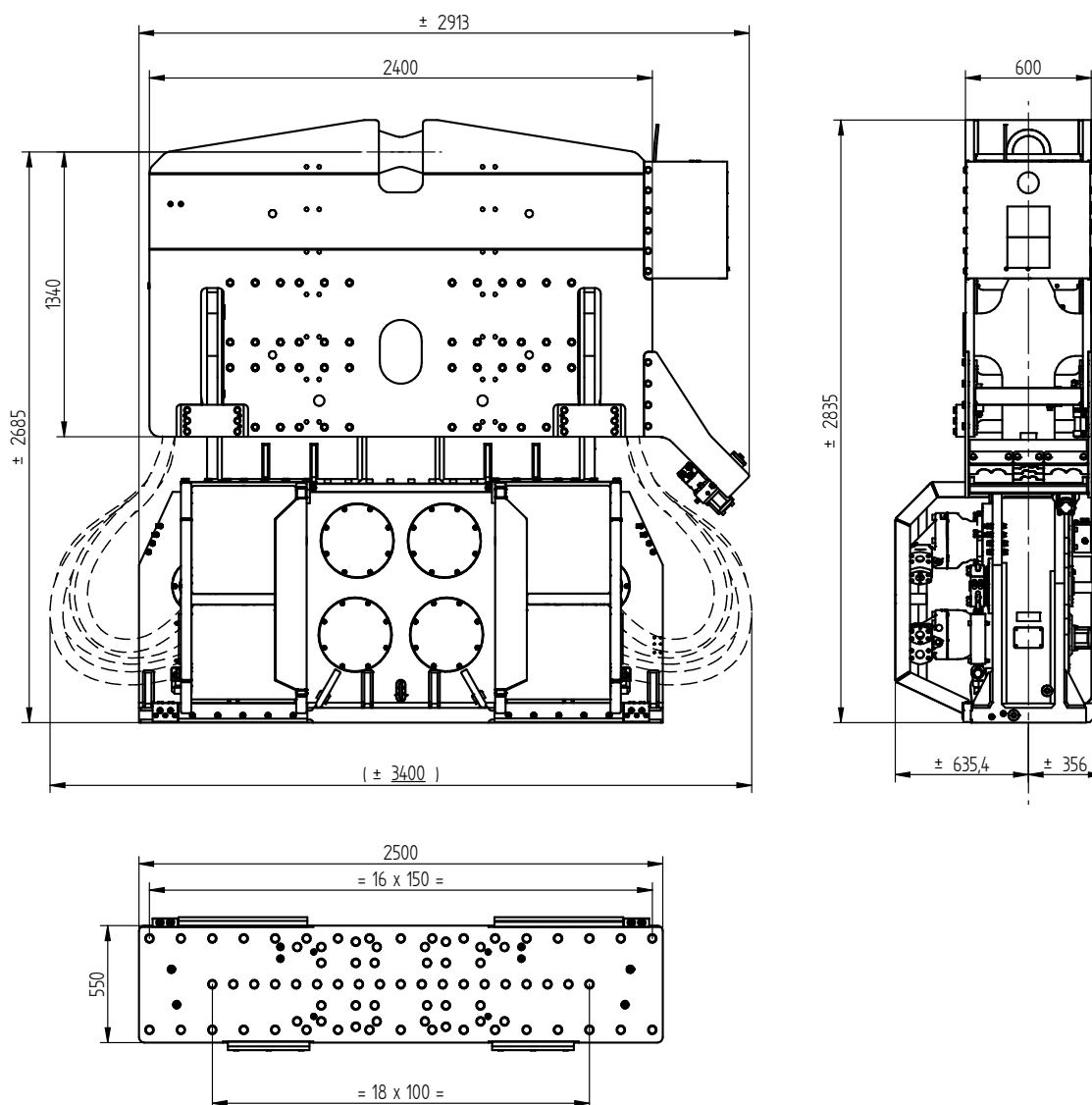

Specificatii :		PVE 50VM	
Moment excentric	0-50 kgm	menghira:	
Forta centrifuga maxima	0-2900 kN	menghina pentru palplanse	350TU
Frecventa maxima	2300 rpm	Greutatea de transport pp.	2600 kg
Amplitudine maxima exclusiva. 350TU	15 mm	menghina dubla	175TC
Amplitudine maxima inclusivă. 350TU	10,9 mm	Greutatea de transport pp.	1300 kg
Tractiune maxima statica	800 kN		
Trage în jos maxima	300 kN		
Presiune maxima de lucru	350 bar	generatoare:	
Debit maxim de ulei	1380 l/min	Model	1400 series
Puterea hidraulică maxima	805/1095 kW/HP		
Lubrifiere fortata	da		
Greutatea dinamica exclusiva. 350TU	6600 kg	Tip de furtun:	
Greutatea dinamica inclusivă. 350TU	9200 kg	Lungimea	45 m
Greutatea totala fara. 350TU si furtun	10060 kg	Greutatea de transport (±)	1970 kg